



alpha

DLD-P AIR VALVE

AIR MANAGEMENT SYSTEMS

PRODUCT PROPERTIES

POWDER COATED METAL DESIGN AIR VALVE

Design air valve **DLD-P** for use as supply or exhaust air valve in ventilation systems. Valve-body and removable screen are manufactured out white powder-coated steel sheet. All sizes are equipped with connection sleeves and integrated, steplessly adjustable throttle screen for flow rate adjustment. For the reduction of dirt entry in/from the ducting system all air valves are supplied with a removable washable aluminium filter.

- Nominal size 100, 125, 160 and 200 mm
- White powder-coated steel sheet (RAL 9010)
- Also available in stainless steel
- Removable screen
- Integrated variable adjustable throttle
- Connection for direct assembly with flexible ducts
- Washable aluminum expanded metal filter

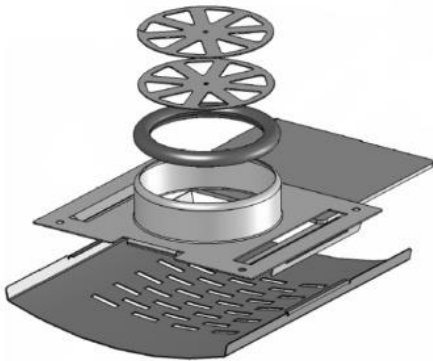

DIMENSIONS (IN MILLIMETRES)

| DLD-P | Ø100 | Ø 125 | Ø 160 | Ø 200 |
|----------|------|-------|-------|-------|
| A | 30 | 30 | 30 | 30 |
| B | 98 | 123 | 158 | 198 |
| C | 210 | 210 | 270 | 320 |
| D | 182 | 207 | 242 | 282 |
| E | 150 | 175 | 210 | 250 |
| F | 130 | 155 | 190 | 230 |
| G | 5.5 | 5.5 | 5.5 | 5.5 |
| H | 180 | 205 | 240 | 280 |
| J | 150 | 175 | 210 | 250 |

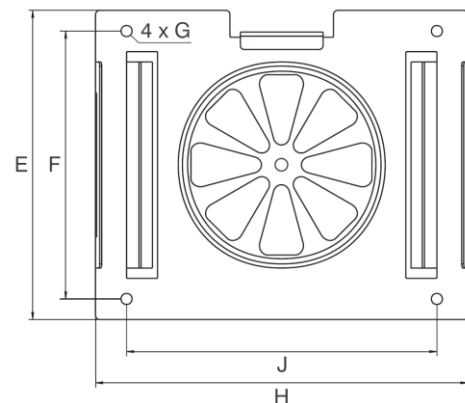
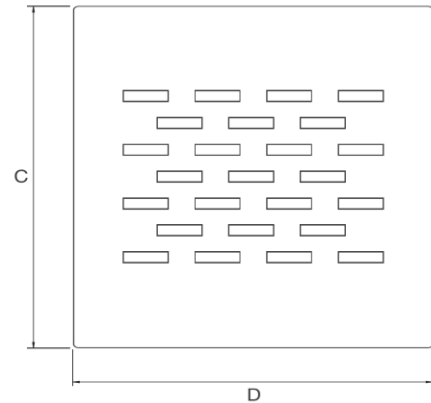
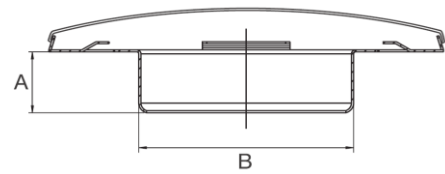

LIABILITY:

The information contained in this brochure was current on the publication date. DEC INTERNATIONAL reserves the right to make changes in details at any time without prior notice. In order to avoid misunderstandings, any interested party is advised to contact DEC INTERNATIONAL checking for any changes in materials and/or information after this brochure was published.

PLEASE NOTICE:

The consultant is responsible for the actual installation and mounting of the product. The mentioned values with respect to temperatures are not appropriate to be used to determine the physical properties. These properties are also dependent on humidity and the temperature of the air inside and outside of the H.V.A.C. system.

TRADEMARKS:

DEC International and the DEC logo are trademarks, or registered trademarks of Dutch Environment Corporation BV in the Netherlands and/or other countries.



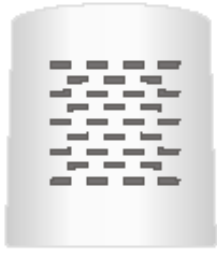

alpha

DLD-P
AIR VALVE
AIR MANAGEMENT SYSTEMS

1 without filter & fully opened, 2 with clean filter & fully opened, 3 with clean filter, 50 % opened
Measurement: Filter in the pure/clean condition !

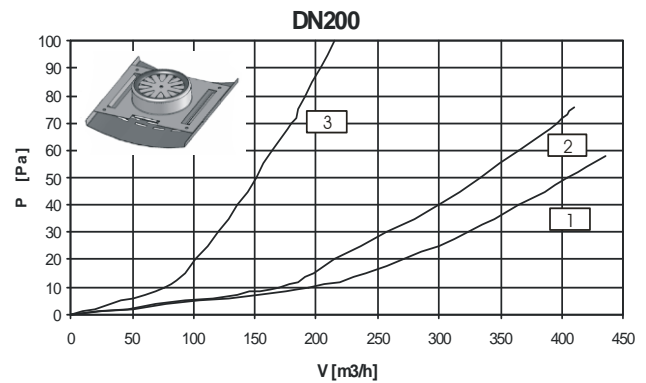
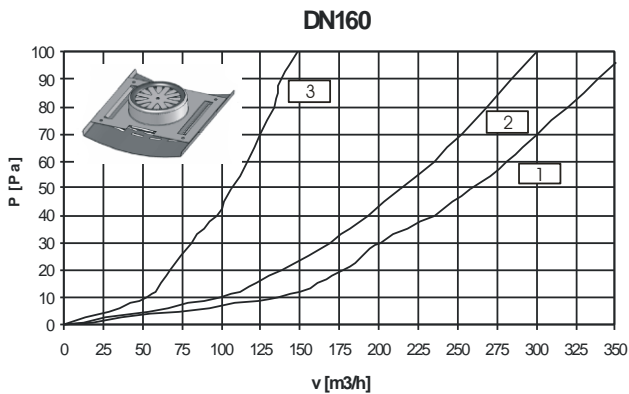
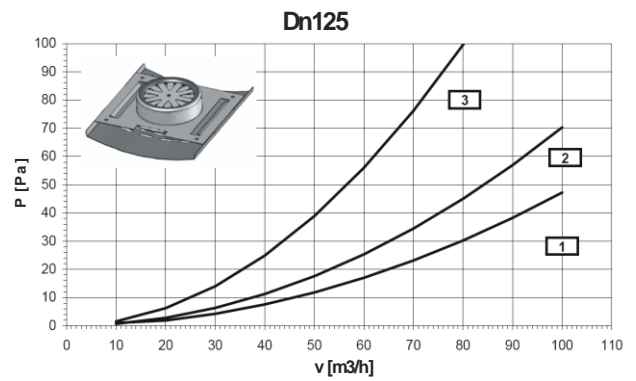
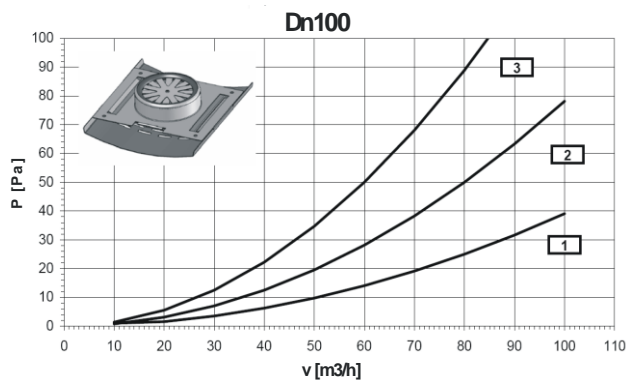

LIABILITY:

The information contained in this brochure was current on the publication date. DEC INTERNATIONAL reserves the right to make changes in details at any time without prior notice. In order to avoid misunderstandings, any interested party is advised to contact DEC INTERNATIONAL checking for any changes in materials and/or information after this brochure was published.

PLEASE NOTICE:

The consultant is responsible for the actual installation and mounting of the product. The mentioned values with respect to temperatures are not appropriate to be used to determine the physical properties. These properties are also dependent on humidity and the temperature of the air inside and outside of the H.V.A.C. system.

TRADEMARKS:

DEC International and the DEC logo are trademarks, or registered trademarks of Dutch Environment Corporation BV in the Netherlands and/or other countries.

