



DAV EXHAUST/SUPPLY AIR VALVE

AIR MANAGEMENT SYSTEMS

PRODUCT PROPERTIES

DAV exhaust/supply air valve is a circular disc valve with a valve cone of aero-dynamic design. Excellent characteristics with regard to noise level, pressure drop and air flow capacity. Designed for wall- or ceiling mounting. The design of the valve in conjunction with a foam packing prevents dirtying of the ceiling and walls.

Material

The valve is made of polypropylene plastic which is recyclable and withstands temperatures up to 110 °C. The materials used in the device are also resistant to most chemicals in small concentrations. The device is supplied in white as standard (RAL9010). Galvanized steel sheet mounting rings, with and without rubber seals, are available as an accessory.

- Available in diameter 100, 125, 150, 160 and 200mm.
- Manufactured from white polypropylene (RAL 9010).
- The valve is difficult to ignite (Will not burn with open flame)
- The valve material has a melting point between 150-180°C
- The valve resists temp. up to 110 °C without deformation
- High valve body improving air flow/less noise
- Closed disc
- Spring connection
- Variable volume flow control
- Suitable for rooms with high air humidity (e.g. kitchen, bathroom)
- Simple removal for cleaning (The device can be wiped down with a mild detergent)

Adjustment

The cone is screwed out by the number of revolutions necessary to provide the orifice opening in mm corresponding to the pressure drop and the desired air flow according to the graph. The pressure drop is checked by introducing a suitable measurement probe into the front behind the valve cone.

SPECIFICATIONS

DAV	A	B	C	D	E
100	140	69	20	80	60
125	165	92	20	104	60
150	191	118	20	130	62
160	200	126	20	143	62
200	242	170	20	177	65

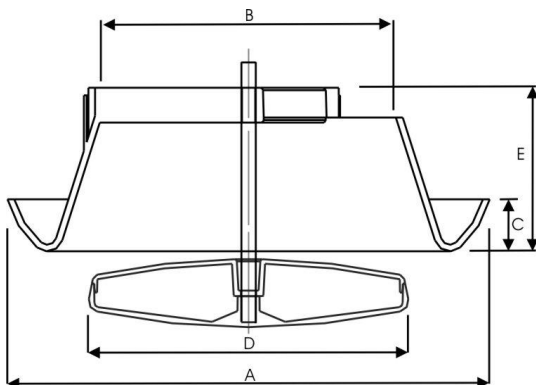

LIABILITY:

The information contained in this brochure was current on the publication date. DEC INTERNATIONAL reserves the right to make changes in details at any time without prior notice. In order to avoid misunderstandings, any interested party is advised to contact DEC INTERNATIONAL checking for any changes in materials and/or information after this brochure was published.

PLEASE NOTICE:

The consultant is responsible for the actual installation and mounting of the product. The mentioned values with respect to temperatures are not appropriate to be used to determine the physical properties. These properties are also dependent on humidity and the temperature of the air inside and outside of the H.V.A.C. system.

TRADEMARKS:

DEC International and the DEC logo are trademarks, or registered trademarks of Dutch Environment Corporation BV in the Netherlands and/or other countries.





DAV EXHAUST AIR VALVE

AIR MANAGEMENT SYSTEMS

PRESSURE LOSS EXHAUST

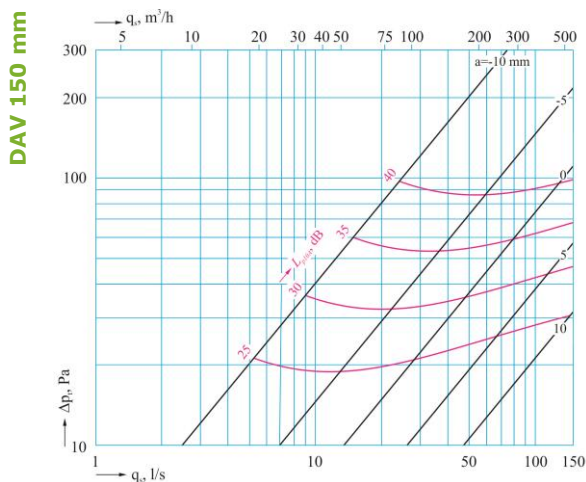
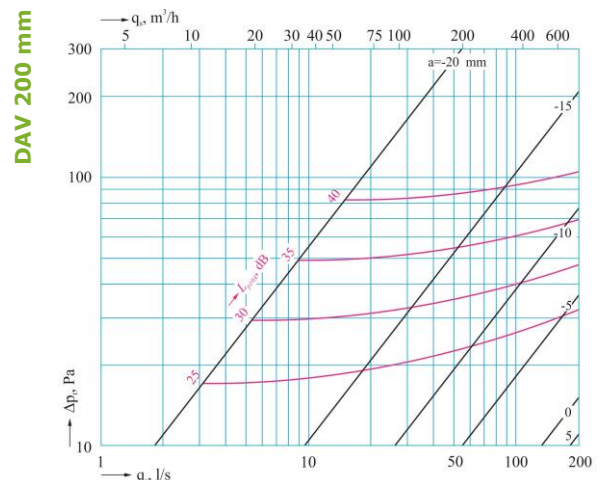
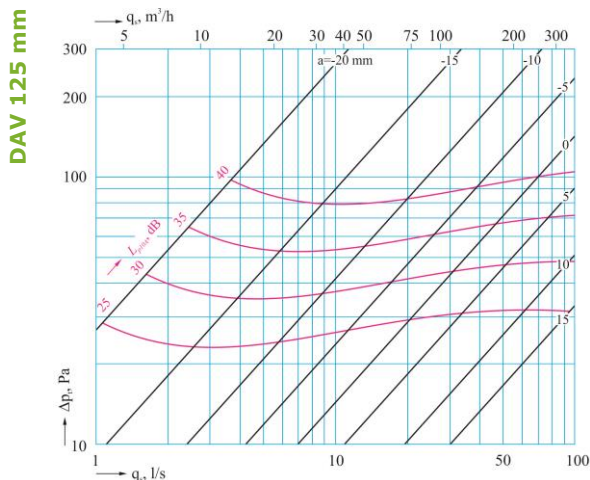
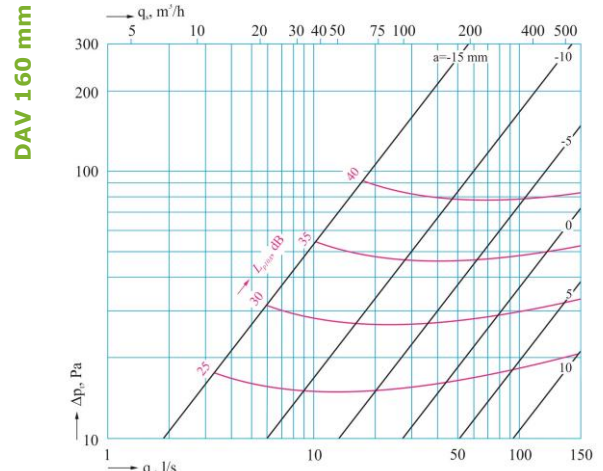
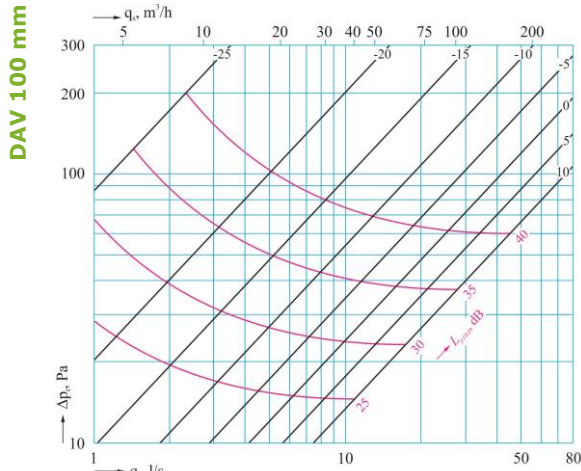

a = opening in mm

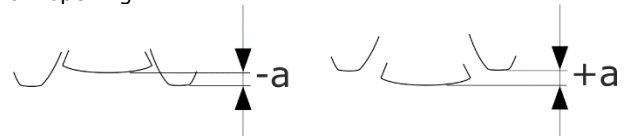

LIABILITY:
The information contained in this brochure was current on the publication date. DEC INTERNATIONAL reserves the right to make changes in details at any time without prior notice. In order to avoid misunderstandings, any interested party is advised to contact DEC INTERNATIONAL checking for any changes in materials and/or information after this brochure was published.

PLEASE NOTICE:
The consultant is responsible for the actual installation and mounting of the product. The mentioned values with respect to temperatures are not appropriate to be used to determine the physical properties. These properties are also dependent on humidity and the temperature of the air inside and outside of the H.V.A.C. system.

TRADEMARKS:
DEC International and the DEC logo are trademarks, or registered trademarks of Dutch Environment Corporation BV in the Netherlands and/or other countries.





DAV SUPPLY AIR VALVE

AIR MANAGEMENT SYSTEMS

PRESSURE LOSS SUPPLY

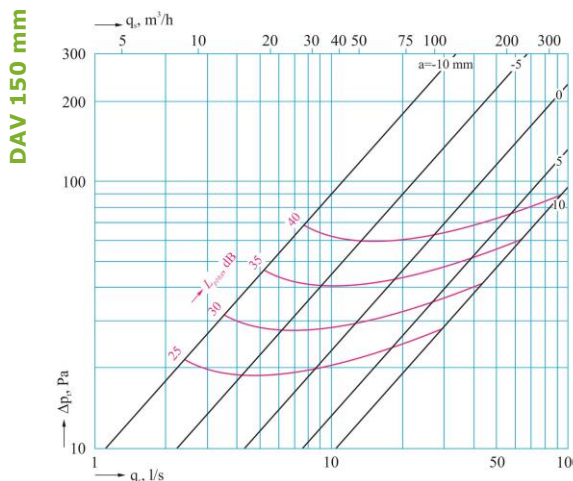
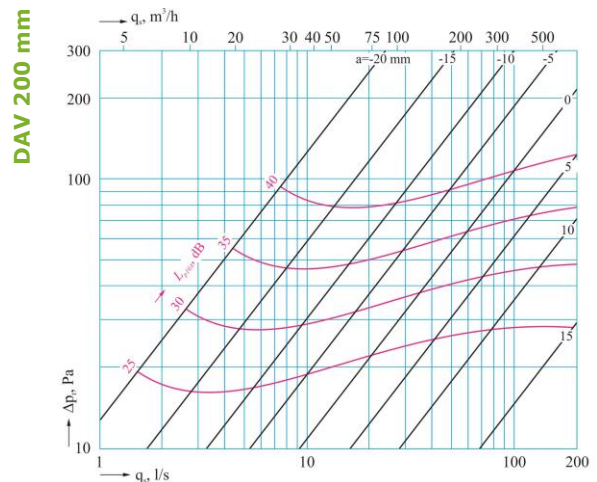
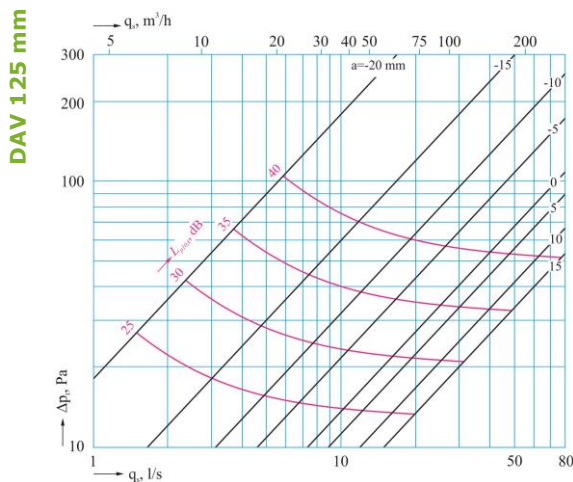
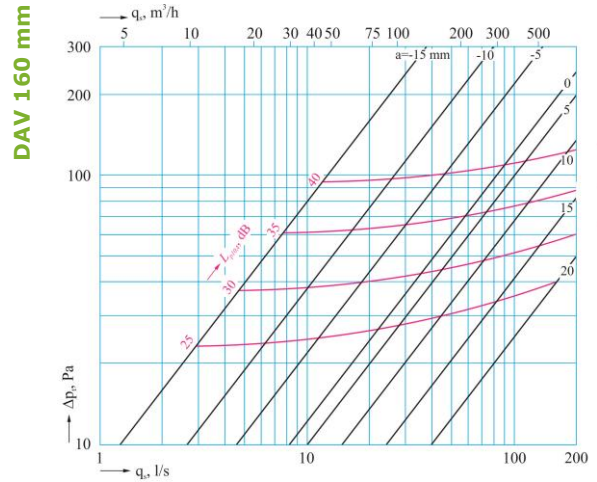
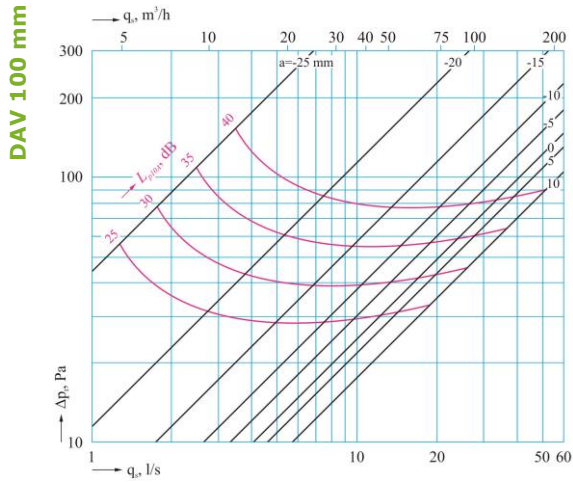

a = opening in mm

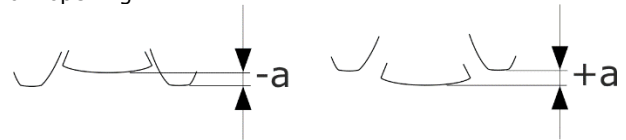

LIABILITY:
The information contained in this brochure was current on the publication date. DEC INTERNATIONAL reserves the right to make changes in details at any time without prior notice. In order to avoid misunderstandings, any interested party is advised to contact DEC INTERNATIONAL checking for any changes in materials and/or information after this brochure was published.

PLEASE NOTICE:
The consultant is responsible for the actual installation and mounting of the product. The mentioned values with respect to temperatures are not appropriate to be used to determine the physical properties. These properties are also dependent on humidity and the temperature of the air inside and outside of the H.V.A.C. system.

TRADEMARKS:
DEC International and the DEC logo are trademarks, or registered trademarks of Dutch Environment Corporation BV in the Netherlands and/or other countries.

